

use & care guide

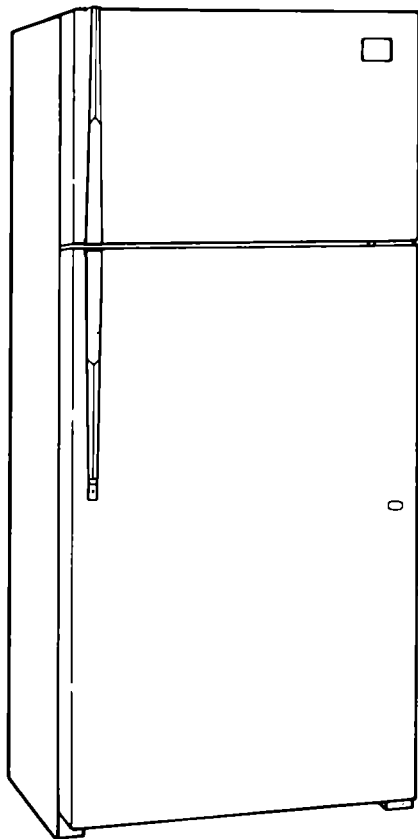

NO-FROST REFRIGERATOR- FREEZER

Model ET18TK

Refrigerators, Freezers, Refrigerator-Freezers, Ice Makers, Dishwashers, Built-In Ovens and Surface Units, Ranges, Microwave Ovens, Trash Compactors, Room Air Conditioners, Dehumidifiers

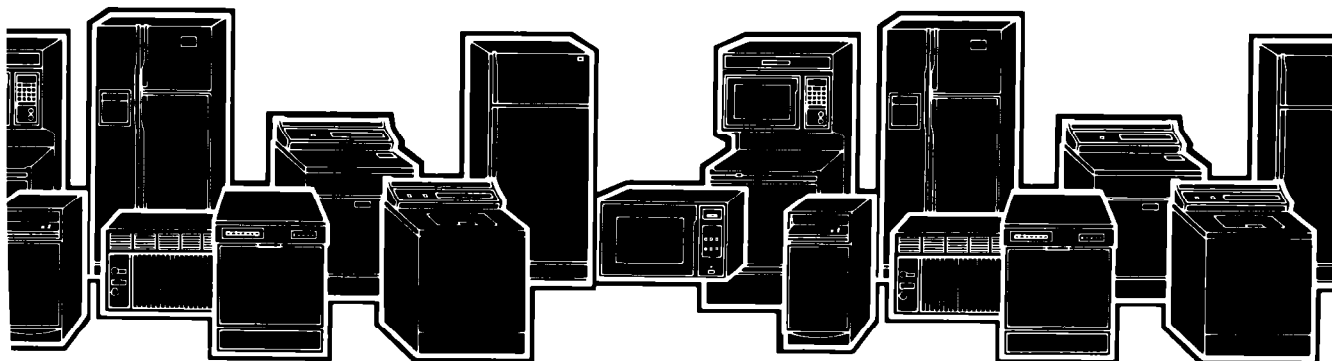

Please read this Use and Care Guide before you do anything else...

This booklet tells you how to start your refrigerator, clean it, move shelves and adjust controls. It even tells you what new sounds to expect from your refrigerator.

Treat your new refrigerator with care. Use it only to do what home refrigerators are designed to do.

Parts and features

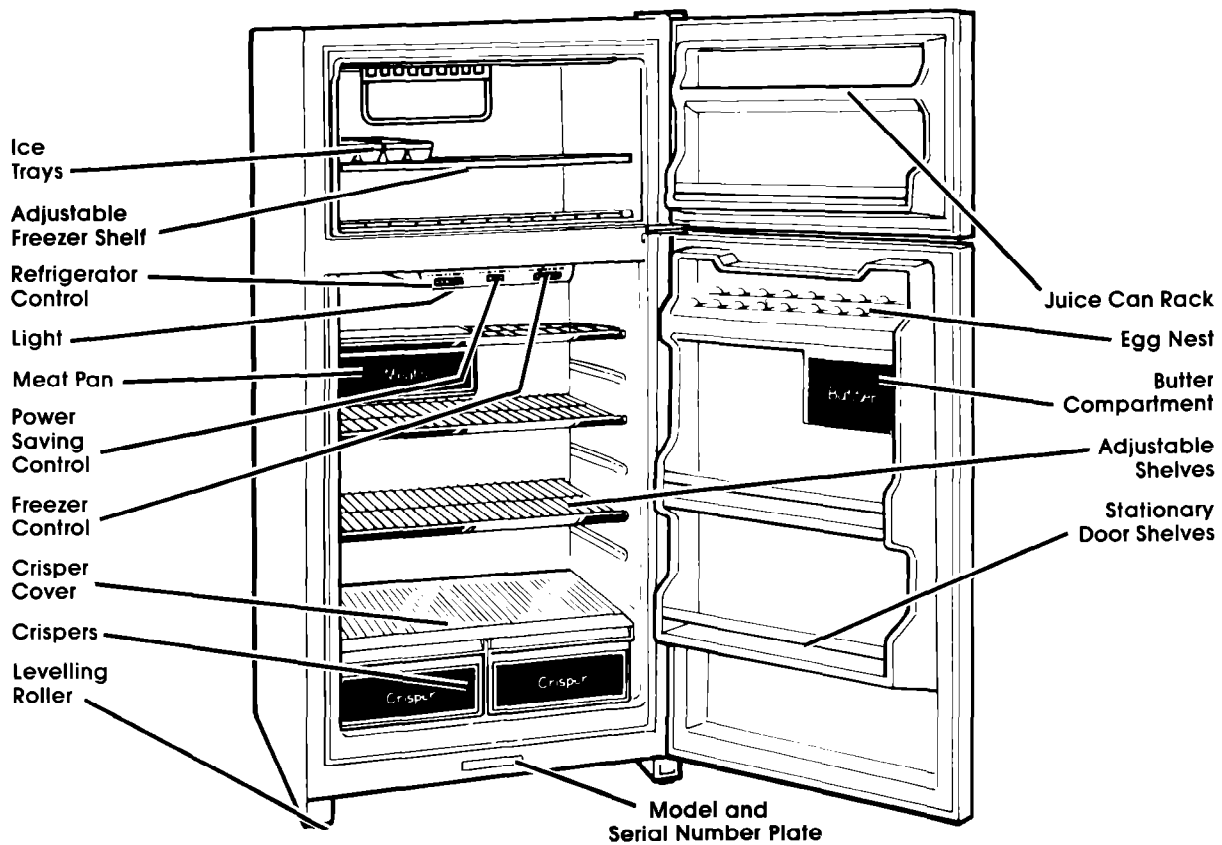

Copy your Model and Serial Numbers here...

When you need service or call with a question, have this information ready:

1. Complete Model and Serial Numbers (from the plate located as shown).

2. Purchase date from sales slip.

Copy this information in these spaces. Keep this book, your warranty and sales slip together in a handy place.

Model Number

Serial Number

Purchase Date

Service Company and Telephone Number

Safety first

Child entrapment, and suffocation, are not things of the past. Junked or abandoned refrigerators are still dangerous... even if they will "just sit in the garage for a few days."

If you are getting rid of your old refrigerator, do it safely. Please read the enclosed safety booklet from the Association of Home Appliance Manufacturers. Help prevent accidents.

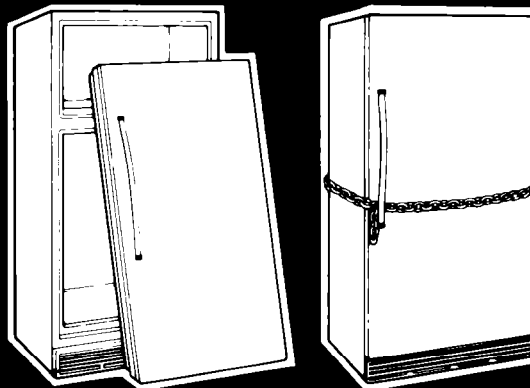

BEFORE USING

PARTS AND FEATURES

Contents

	Page		Page
BEFORE YOU PLUG IT IN	3	Ice Cube Trays	7
Install Properly	4	Optional Automatic Ice Maker	7
Level Refrigerator-Freezer	4	Sounds You May Hear	7
Remove Sales Labels	4	Energy Saving Tips	7
Clean It	4	CLEANING YOUR REFRIGERATOR	7
Plug It In	4	Cleaning Chart	8
USING YOUR REFRIGERATOR	5	FOOD STORAGE GUIDE	9
Setting the Controls	5	Storing Fresh Food	9
Changing the Control Settings	5	Storing Frozen Food	10
Power Saving Control	5	VACATION AND MOVING CARE	10
Changing the Light Bulb	6	IF YOU NEED SERVICE OR ASSISTANCE	11
Moving the Meat Pan and Cover	6	1. Before Calling for Assistance	11
Adjusting the Refrigerator Shelves	6	2. If You Need Assistance	11
Removing the Crispers and Cover	6	3. If You Need Service	11
Adjusting the Freezer Shelf	6	4. If You Have a Problem	11

©1984 Whirlpool Corporation

Before you plug it in

IMPORTANT

Before using your refrigerator, you are personally responsible for making sure that it...

- is installed and leveled on a floor that will hold the weight, and in an area suitable for its size and use.
- is connected only to the right kind of outlet, with the right electric supply and grounding.
- is used only for jobs expected of home refrigerators.
- is not near an oven, radiator or other heat source.
- is properly maintained.
- is out of the weather.
- is used in an area where the room temperature will not fall below 55° F (13° C).
- is not run where there are explosive fumes.
- is not used by children or others who may not understand how it should be used.
- is not loaded with food before it has time to get properly cold.

Install properly...

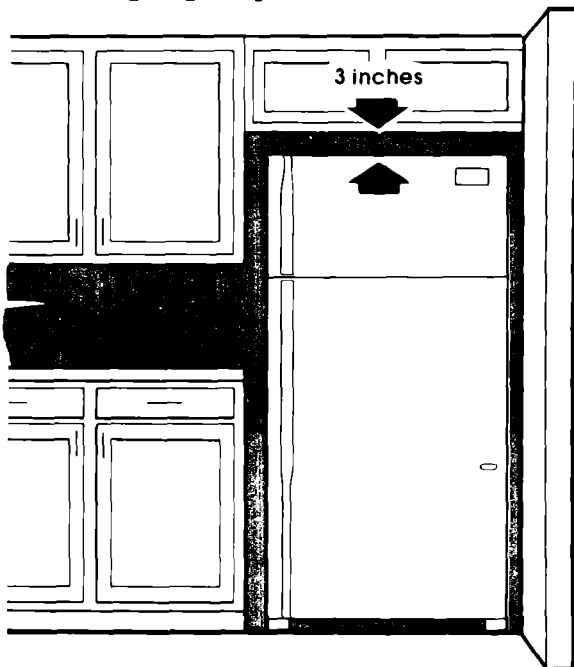

1. Allow 3 inches (7.5 cm) between overhead cabinets and the refrigerator top.
2. Allow at least an inch (2.5 cm) between the refrigerator condenser and the wall.
3. Allow ½ inch (1.25 cm) on each side of the refrigerator for ease of installation.
4. If the refrigerator is to be against a wall, you might want to leave enough space so the door can be opened wider.

Level refrigerator-freezer...

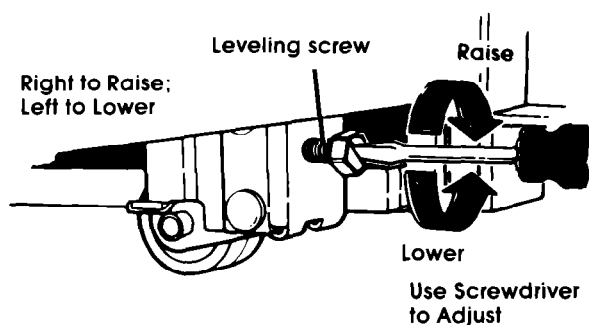

1. To raise front, turn each screw to the right.
2. To lower front, turn each screw to the left.
3. Check with level.

Remove sales labels...

Remove the Consumer Buy Guide label and other inside labels before using the refrigerator. Any glue left can be taken off with rubbing alcohol.

NOTE: DO NOT REMOVE ANY PERMANENT INSTRUCTION LABELS INSIDE YOUR REFRIGERATOR.
Do not remove the Tech Sheet fastened under the refrigerator at the front.

Clean it...



Clean your refrigerator before using it. See cleaning instructions on page 8.

Plug it in...

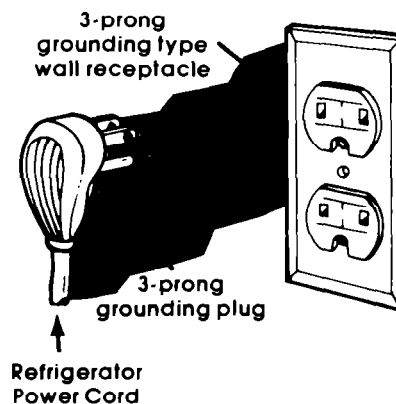

RECOMMENDED GROUNDING METHOD

A 115 Volt, 60 Hz., AC only 15 or 20 ampere fused and properly grounded electrical supply is required. It is recommended that a separate circuit serving only this appliance be provided.

Do not use an extension cord. Use a receptacle which cannot be turned off with a switch or pull chain. See individual electrical requirements and grounding instruction sheet in your literature package.

Using your refrigerator

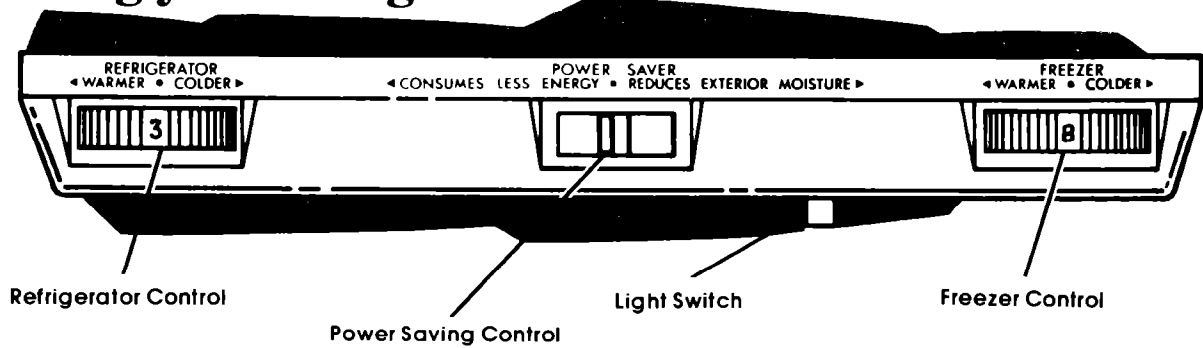

Setting the controls...

Controls for the refrigerator and freezer are in the refrigerator. When the refrigerator is plugged in for the first time...

1. Set the REFRIGERATOR CONTROL to 3.



2. Set the FREEZER CONTROL to B.



Give the refrigerator time to cool down completely before adding food. (This may take several hours.)

These settings should be about right for normal household refrigerator usage.

The controls will be set about right when milk or juice is as cold as you like and when ice cream is firm.

Changing the control settings...

If you need to adjust temperatures in refrigerator or freezer, use the settings listed in the chart below.

- Adjust the Refrigerator Control first.
- Wait at least 24 hours between adjustments.
- Then adjust the Freezer Control, if needed.



CONDITION:	REASONS:	RECOMMENDED CONTROL SETTINGS:
If Refrigerator Section is TOO WARM	Door opened often	Refrigerator 4
	Large amount of food added	Freezer C
	Room temperature too warm	
If Freezer Section is TOO WARM	Door opened often	Refrigerator 3
	Large amount of food added	Freezer A
	Very cold room temperature (can't cycle often enough)	
If Refrigerator Section is TOO COLD	Controls not set correctly for your conditions	Refrigerator 2
		Freezer B
If ICE isn't MADE FAST ENOUGH	Heavy ice usage	Refrigerator 3
	Very cold room temperature	Freezer A
	(can't cycle often enough)	
If BOTH SECTIONS are TOO WARM	Door opened often	Refrigerator 4
	Large amount of food added	Freezer B
	Very warm or very cold room temperatures	

Power Saving Control...

The **Power Saving Control** on the Control Console operates electric heaters around the door openings. These heaters help keep moisture from forming on the outside of the refrigerator.

POWER SAVER
◀ CONSUMES LESS ENERGY • REDUCES EXTERIOR MOISTURE ▶



1. Use the "CONSUMES LESS ENERGY" setting when humidity is low.
2. Use the "REDUCES EXTERIOR MOISTURE" setting only if moisture forms on the outside of the refrigerator.

Changing the light bulb...

Unplug the refrigerator first.

1. Reach behind control console to find bulb.
2. Remove bulb.
3. Replace with a 40-watt appliance bulb.

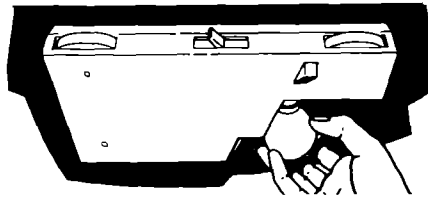

Moving the meat pan and cover...

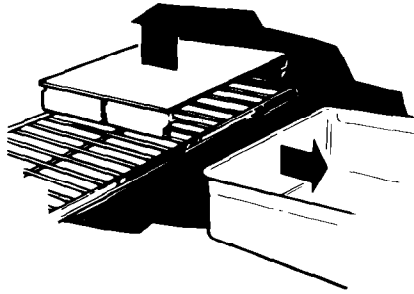

The meat pan and cover can be removed for cleaning and moved to another shelf, if desired. Remove the meat pan first.

Removing:

1. Slide the pan out to stop.
2. Lift the front of meat pan.
3. Slide pan the rest of the way out.
4. Tilt cover up at front.
5. Pull forward and out.

Replacing:

1. Fit notches underneath cover over rear and center cross bars on shelf.
2. Lower cover in place.
3. Replace meat pan in reverse order.

Adjusting the refrigerator shelves...

1. First, remove food from shelf.
2. Slide shelf straight out to stop.
3. Lift front.
4. Slide the rest of the way out.

Replacing Shelf:

1. Fit back of shelf on top of guides with wire stops on the bottom of guides.
2. Lift front, slide shelf in until it clears guide stops.

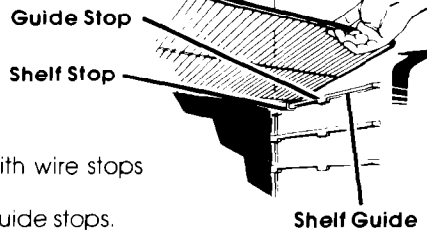

Removing crispers and crisper cover...

Removing the Crispers:

1. Slide crisper straight out to stop, lift front, then slide the rest of the way out.
2. Replace in the reverse order.

Removing Cover:

1. Lift front and remove the cover support.
2. Lift out cover by pulling up and out.

Replacing Cover:

1. Fit back of cover into notch supports on walls of refrigerator, then lower front into place.
2. Replace cover support with the long tab towards the front. **Note:** If support needs adjustment, turn base right to lower, or left to raise.

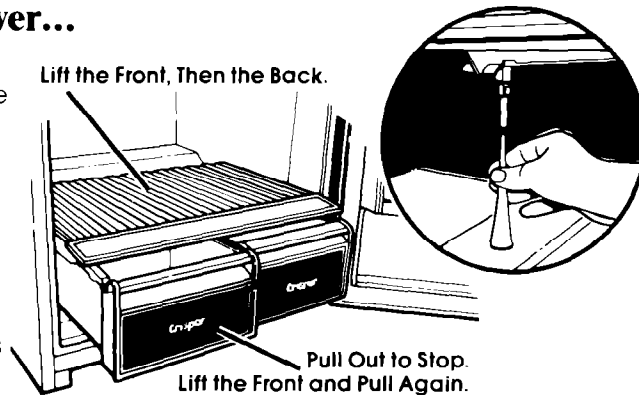

Removing and Adjusting the freezer shelf...

To remove shelf:

1. Lift front slightly.
2. Lift back off supports.
3. Replace in reverse order.

To adjust shelf:

1. Remove shelf.
2. Remove supports by sliding upwards.
3. Replace supports on desired level.
4. Replace shelf.

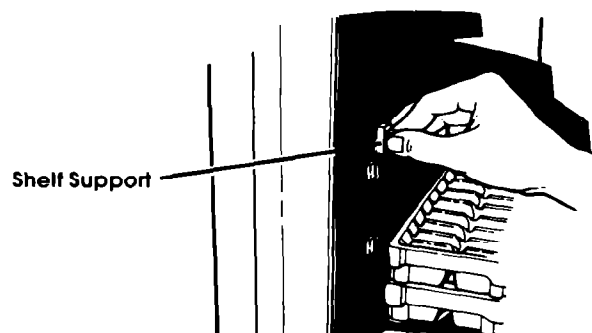

Ice cube trays...

To remove ice:

1. Hold tray at both ends.
2. Slightly twist.

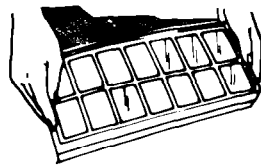

If cubes are not used, they may shrink. The moving cold air starts a slow evaporation. The longer cubes are stored, the smaller they get.

Optional automatic ice maker...

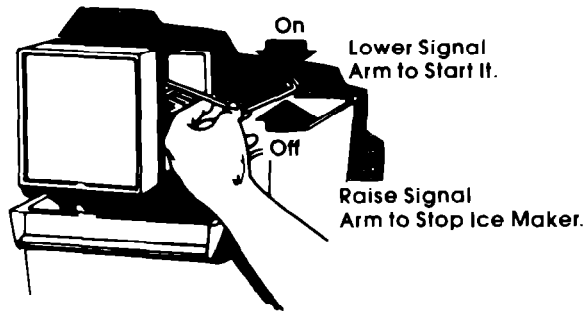

If you have the automatic ice maker accessory or plan to add one later (Part No. ECKMF-83), there are a few things you will want to know:

- The ON/OFF lever is a wire signal arm.
Down...for making ice automatically;
Up...to shut off the ice maker
- Shake the bin occasionally to keep cubes separated, and to obtain increased storage capacity.

- It is normal for ice crescents to be attached by a corner. They will break apart easily.
- You will hear water running when ice maker is working. You'll hear ice fall into the bin. Don't let these sounds bother you.
- The ice maker will not operate until the freezer is cold enough to make ice. This can take overnight.
- Because of new plumbing connections, the first ice may be discolored or off-flavored. Discard the first few batches of ice.
- If ice is not being made fast enough and more ice is needed, turn the Refrigerator Control toward a higher number. Wait a day and, if necessary, turn the Freezer Control toward A.
- If you remove the ice bin, raise the signal arm to shut off the ice maker. When you return the bin, push it all the way in and lower the arm to the ON position.
- If cubes are stored too long, they may develop an off-flavor...like stale water. Throw them away. They will be replaced. Cubes in the ice bin can also become smaller by evaporation.

Sounds you may hear...



Your new refrigerator may make sounds that your old one didn't. Because the sounds are new to you, you might be concerned about them. Don't be. Most of the new sounds are normal. Hard surfaces like the floor, walls and cabinets can make the sounds seem louder.

The following chart describes the kinds of sounds that might be new to you, and what may be making them.

Possible Sounds:	Probable Causes:
• Slight Hum, Soft Hiss:	Your refrigerator has a fan; you may hear the fan motor and moving air.
• Clicking or Snapping Sounds:	The defrost timer makes a definite click when the refrigerator stops running. It also makes a sound when the refrigerator starts.
• Water Sounds:	When the refrigerator stops running, you may hear gurgling in the tubing for a few minutes after it stops. You may also hear defrost water running into the defrost water pan.
• Ice Maker Sounds: – trickling water – thud (clatter of ice)	If your refrigerator has an ice maker, you may hear buzzing (from the water valve), trickling water and the clatter of ice dumped into the bin.
• Running Sounds:	Your refrigerator has a high-efficiency compressor and motor. It will run longer than older designs. It may even seem to run most of the time.

Energy saving tips...

You can help your refrigerator use less electricity.

- Check door gaskets for a tight seal. Level the cabinet to be sure of a good seal.
- Clean the condenser coil regularly.
- Open the door as few times as possible. Think about what you need before you open the door. Get everything out at one time. Keep foods organized so you won't have to search for what you want. Close door as soon as food is removed.
- Go ahead and fill up the refrigerator, but don't overcrowd it so air movement is blocked.
- It is a waste of electricity to set the refrigerator and freezer to temperatures colder than they need to be. If ice cream is firm in the freezer and drinks are as cold as your family likes them, that's cold enough.
- Keep the Power Saving Control on CONSUMES LESS ENERGY unless moisture forms on refrigerator exterior.
- Make sure your refrigerator is not next to a heat source such as a range, water heater, furnace, radiator, or in direct sunlight.

Cleaning your refrigerator

Both the refrigerator and freezer sections defrost automatically. But both should be cleaned about once a month to help prevent odors from building up. Of course, spills should be wiped up right away.

To clean your refrigerator, turn the Refrigerator Control to OFF, unplug it, take out all removable parts, and clean it according to the following directions.



Cleaning chart...

Part	What to use	How to clean
Removable parts (shelves, crisper, meat pan etc.)	Mild detergent and warm water.	<ul style="list-style-type: none"> • Wash removable parts with warm water and a mild detergent. • Rinse and dry.
Outside	Sponge, cloth or paper towel; mild detergent; appliance wax (or good auto paste wax).	<ul style="list-style-type: none"> • Wash with warm water and a mild detergent. Do not use abrasive or harsh cleansers. • Rinse and dry. • Wax painted metal surfaces at least twice a year with appliance wax or a good auto paste wax. Apply wax with a clean, soft cloth. Do not use wax on plastic parts. <p style="text-align: center;">Waxing painted metal surfaces provides rust protection.</p>
Inside walls (Freezer should be allowed to warm up so cloth won't stick.)	Sponge, soft cloth or paper towel, baking soda, warm water, mild detergent.	<ul style="list-style-type: none"> • Wash with warm water and <ul style="list-style-type: none"> – mild detergent or – baking soda (2 tablespoons [26 g] to 1 quart [.95 l] warm water. • Rinse and dry.
Door liners and gaskets	Sponge, soft cloth or paper towel; mild detergent, warm water.	<ul style="list-style-type: none"> • Wash with mild detergent and warm water. • Rinse and dry. <p style="text-align: center;">DO NOT USE Cleaning waxes, concentrated detergents, bleaches or cleansers containing petroleum on plastic parts.</p>
Dark plastics (covers and panels)	Mild detergent and warm water; soft, clean sponge and soft, clean cloth.	<ul style="list-style-type: none"> • Wash with a soft grit-free cloth or sponge. • Rinse and dry with a damp grit-free cloth or chamois. <p style="text-align: center;">DO NOT USE paper towels, window sprays, scouring cleansers, or flammable or toxic solvents like acetone, gasoline, carbon tetrachloride, etc. These can scratch or damage the material.</p>
Defrost pan (behind refrigerator on top of motor)	Warm water and mild detergent.	<ul style="list-style-type: none"> • Roll refrigerator away from wall. • Wash defrost pan with warm water and mild detergent. Do not remove defrost pan to clean. • Rinse and dry. • Roll refrigerator back into place.
Condenser coil	Use vacuum cleaner with brush attachment.	<ul style="list-style-type: none"> • Clean dust and lint from the condenser coil behind the refrigerator at least every other month.
Floor under refrigerator	Usual floor cleaner.	<ul style="list-style-type: none"> • Roll refrigerator away from wall. • Wash floor. • Roll refrigerator back into place. • Check to see if refrigerator is level.

Food storage guide

STORING FRESH FOOD



There is a right way to package and store refrigerated or frozen foods. To keep foods fresher, longer, take the time to study these recommended steps.

Leafy Vegetables ...Remove store wrapping. Trim or tear off bruised and discolored areas. Wash in cool water, drain and store in crisper. Cold, moist air helps keep leafy vegetables fresh and crisp.

Vegetables with Skins (carrots, peppers)... Store in crisper, plastic bags or plastic container.

Fruits ...Wash, let dry and store in refrigerator in plastic bags or crisper. Do not wash or hull berries until they are ready to use. Sort and keep berries in their store container in a crisper, or store in a loosely closed paper bag on a refrigerator shelf.



Meat ...Meat is perishable and expensive...you won't want to waste an ounce of it through careless handling. The following list and chart give you packaging hints and time limits. Store meat in the meat pan.

Fresh, Prepackaged Meat. Store fresh meat in the store wrapping. Vacuum packaged meat can be frozen for as long as one month if the seal is not broken. If you want to keep it frozen longer, you should wrap it with special freezer wrapping material.

Fresh Meat, Not Prepackaged. Remove the market wrapping paper and re-wrap loosely in waxed paper or aluminum foil for storing it unfrozen.

Cooked Meat. Wrap or cover cooked meat with waxed paper, plastic wrap or aluminum foil. Store immediately.

Cured or Smoked Meat and Cold Cuts. Ham, bacon, sausage, cold cuts, etc., keep best in original wrappings. Once opened, tightly re-wrap in plastic wrap or aluminum foil.

Canned Ham. Store in refrigerator unless the label says it's okay to store on the shelf. Do not freeze.

Fresh Poultry ...Loosely wrap in waxed paper or plastic wrap. The plastic wrap on poultry, as purchased, may be used for storage.

STORAGE CHART FOR FRESH AND CURED MEAT*

Type	Approximate Time (days)
Variety Meats	1 to 2
Chicken	1 to 2
Ground Beef	1 to 2
Steaks and Roasts	3 to 5
Cured Meats	7 to 10
Bacon	5 to 7
Cold Cuts	3 to 5

*If meat is to be stored longer than the times given, follow the directions for freezing.

NOTE: Fresh fish and shellfish should be used the same day as purchased.

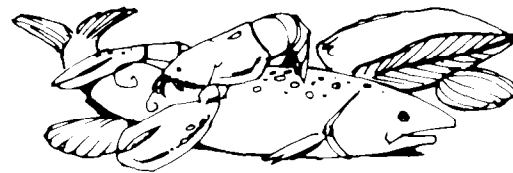

Eggs ... Store without washing in the original carton or use the egg nest in the door of your refrigerator.

Milk ...Wipe milk cartons. For best storage, place milk on interior shelf.

Beverages ...Wipe bottles and cans. Store on a door shelf or inside the refrigerator.

Butter ...Keep opened butter in covered dish or in the Butter Compartment. When storing an extra supply, wrap in freezer packaging and freeze.

Cheese ... Store in the original wrapping until you are ready to use it. Once opened, re-wrap tightly in plastic wrap or aluminum foil.

Condiments ... Store small jars and bottles (cat-sup, mustard, jelly, olives) on the door shelves where they are in easy reach.

Leftovers ...Cover leftovers with plastic wrap or aluminum foil to keep food from drying out and transferring food odors. Plastic containers with tight lids are fine, too.

STORING FROZEN FOOD

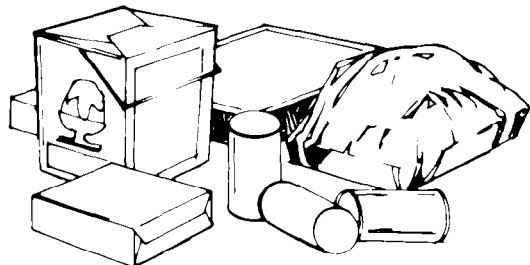

The freezer section is designed for storage of commercially frozen foods and for freezing foods at home.

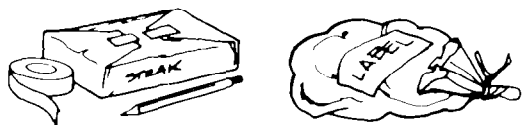

Packaging – The secret of successful freezing is in the packaging. The wrap you use must be air, moisture and vapor proof. The way you close and seal the package must not allow air, moisture or vapors in or out.

Rigid polyethylene (plastic) containers with tight-fitting lids, straight-sided canning freezing jars, heavy-duty aluminum foil, plastic-coated paper and non-permeable plastic wraps (such as saran) are recommended. Note: Heat-sealed boiling bags are easy to use and can be used by themselves or as carton liners.

IMPORTANT: Do not expect your freezer to quick-freeze any large quantity of food. Leave enough space for air to circulate around packages. Be careful to leave enough room at the front so the door can close tightly.

Ice Cream ... Store in the freezer. Once the package is opened, place a piece of aluminum foil or waxed paper smoothly against the ice cream surface. This will prevent ice crystals from forming.

Packaged Frozen Food ... Store on freezer door shelf or in the freezer. If you plan to store it for a long time, re-wrap it with aluminum foil or plastic wrap.

Frozen Meats ... The following hints will help keep the quality in your frozen meats:

1. Freeze meat while fresh and in top condition.
2. Use only recommended wrapping materials.
3. Prepare the meat for freezing before wrapping it. Trim off excess fat and remove bones when practical. Meat should not be salted because salt shortens freezer life.
4. Wrap tightly, pressing out as much air as possible.
5. Label and date it.
6. Refreezing thawed meat is not recommended.

Frozen Soups, Juices ... Store on freezer door shelf or in the freezer.

STORAGE CHART FOR FROZEN FOOD

Storage times given in this chart are only a guide. For best use of freezer space, keep frozen foods for short times. Use, then replace as needed.

Bread	2 months
Cooked Dishes	2-3 months
Fish and Seafoods	
Fresh	6 months
Commercially Frozen	1-3 months
Fruits	6 months
Ice Cream	1 month
Concentrated Juice	4-6 months
Meats	
Bacon	Less than 1 month
Pork roasts, chops	3-4 months
Sausage	1-2 months
Beef, veal, lamb roasts	6 months
Ground meat	1-2 months
Poultry	3-4 months
Vegetables	6 months

*Courtesy of National Livestock and Meat Board and U.S.D.A.

Vacation and moving care

Short vacations. . .

No need to shut off the refrigerator if you will be away for less than four weeks. Use up perishables, freeze other items. If your refrigerator is equipped with an automatic ice maker, 1) turn it off; 2) shut off the water supply to the ice maker; 3) empty the ice bin.

Long vacations. . .

Remove all the food if you are going for a month or more. If your refrigerator is equipped with an automatic ice maker, turn off the water supply to

the ice maker at least a day ahead. When the last load of ice drops, turn off the ice maker.

Unplug the refrigerator and clean it...rinse well and dry. Tape rubber or wood blocks to both doors ...keeping them open far enough for air to get in. This will keep odor and mold from building up.

Tape the blocks out of a child's reach...do not allow children near the refrigerator when the doors are blocked open.

To restart refrigerator, see "Using Your Refrigerator."

Moving...

If your refrigerator is equipped with an automatic ice maker, shut off the ice maker water supply a day ahead of time. Disconnect the water line. After the last supply of ice drops, lift the signal arm to turn off the ice maker.

Remove all food. Pack frozen foods in dry ice. Unplug the refrigerator and clean it thoroughly.

If you need service or assistance, we suggest you follow these four steps:

1. Before calling for assistance...

Performance problems often result from little things you can find and fix yourself without tools of any kind.

If your refrigerator will not operate:

- Is the electric cord plugged in?
- Is a fuse blown or a circuit breaker tripped?
- Is the Refrigerator Control turned ON?

If there is a rattling or jingling noise, or other unfamiliar sounds:

- Is something on top or behind the refrigerator making noise when the refrigerator is running?
- New features on your new refrigerator make new sounds. You may be hearing air flowing from the fans, timer clicks for the defrosting cycle, defrost water draining into the defrost pan.

If there is water in the defrost pan:

- In hot, muggy weather, this is normal! The pan can even be half full. Make sure the refrigerator is level so the pan doesn't overflow.

If the light doesn't work:

- Check fuses and circuit breakers. Make sure it's plugged in.

If a bulb is burned out:

- See instructions for changing light bulbs on page 6. Use appliance bulbs only.

If the motor seems to run too much:

- Is the condenser, behind the refrigerator, free of dust and lint?
- On hot days, or if the room is warm, the motor naturally runs longer.
- If the doors have been opened a lot, or if a large amount of food has been put in, the motor will run longer to cool down the interior.

Remember: Motor running time depends on different things: number of door openings, amount of food stored, temperature of the room, setting of the controls.

And, your new refrigerator may be larger than your old one so it has more space to be cooled. It also has a regular freezer instead of a frozen food compartment. All this means better refrigeration and may require more running time than your old one.



FSP is a registered trademark of Whirlpool Corporation for quality parts. Look for this symbol of quality whenever you need a replacement part for your Whirlpool appliance. FSP replacement parts will fit right and work right because they are made to the same exacting specifications used to build every new Whirlpool appliance.

Remove everything that comes out. Wrap all parts well and tape them together so they don't shift and rattle.

Screw in the leveling rollers; tape the doors shut; tape the electric cord to the cabinet. When you get to your new home, put everything back, level it, reconnect the water supply and refer to the "Before Using..." page.

2. If you need assistance* ...

Call Whirlpool COOL-LINE[®] service assistance telephone number. Dial free from:

Continental U.S.	(800) 253-1301
Michigan	(800) 632-2243
Alaska & Hawaii	(800) 253-1121

and talk with one of our trained Consultants. The Consultant can instruct you in how to obtain satisfactory operation from your appliance or, if service is necessary, recommend a qualified service company in your area.

3. If you need service* ...



Whirlpool has a nationwide network of franchised TECH-CARE Service Companies. TECH-CARE service technicians are trained to fulfill the product warranty and provide after-warranty service, anywhere in the United States. To locate

TECH-CARE service in your area, call our COOL-LINE service assistance telephone number (see Step 2), or look in your telephone directory Yellow Pages under

APPLIANCES - HOUSEHOLD - MAJOR - SERVICE & REPAIR	OR	ELECTRICAL APPLIANCES - MAJOR - REPAIRING & PARTS
WHIRLPOOL APPLIANCES FRANCHISED TECH-CARE SERVICE		WHIRLPOOL APPLIANCES FRANCHISED TECH-CARE SERVICE
SERVICE COMPANIES XYZ SERVICE CO. 123 Maple 999-9999		SERVICE COMPANIES XYZ SERVICE CO. 123 Maple 999-9999
OR		
WASHING MACHINES, DRYERS & IRONERS - SERVICING		
WHIRLPOOL APPLIANCES FRANCHISED TECH-CARE SERVICE		
SERVICE COMPANIES XYZ SERVICE CO. 123 Maple 999-9999		

4. If you have a problem* ...

Call our COOL-LINE service assistance telephone number (see Step 2) and talk with one of our Consultants, or if you prefer, write to:

Mr. Robert F. Gurtz, Vice President
Whirlpool Corporation
Administrative Center
2000 US-33 North
Benton Harbor, MI 49022

If you must call or write, please provide: model number, serial number, date of purchase, and a complete description of the problem. This information is needed in order to better respond to your request for assistance.



Making your world a little easier.

Part No. 946416 Rev. A
©1984 Whirlpool Corporation

Printed in U.S.A.

Refrigerators, Dishwashers, Built-In Ovens and Surface Units, Ranges, Microwave Ovens, Trash Compactors, Room Air Conditioners, Dehumidifiers, Automatic Washers, Clothes

